

MONOPRICE

MP Mini Delta 3D Printer

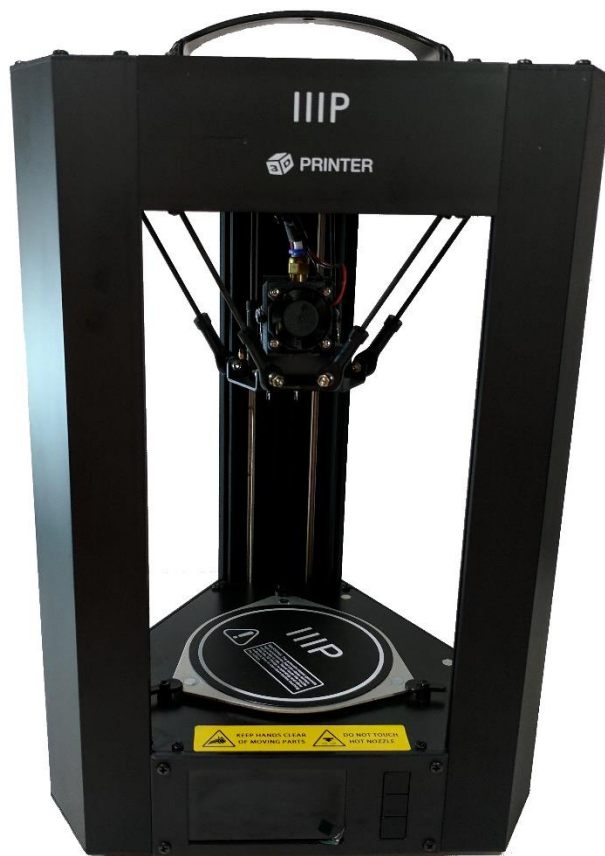

P/N 21666

User's Manual

CONTENTS

SAFETY WARNINGS AND GUIDELINES	3
INTRODUCTION.....	4
FEATURES.....	4
CUSTOMER SERVICE.....	5
PACKAGE CONTENTS	5
PRODUCT OVERVIEW	6
USING THE MENU SYSTEM.....	6
USING THE QUICK ACCESS LED BUTTON	7
PRINTER SETUP.....	8
COMPLETED PRINT REMOVAL	10
WI-FI SETUP.....	10
SOFTWARE INSTALLATION AND SETUP	11
Installing Cura for Windows®	12
Repetier-Host.....	19
TECHNICAL SUPPORT	21
REGULATORY COMPLIANCE.....	21
Notice for FCC	21
Notice for Industry Canada.....	21

SAFETY WARNINGS AND GUIDELINES

- Do not remove the insulating tape on the heater block, which is directly above the nozzle.
- Take care to avoid touching hot parts, including heat blocks, extruder nozzle, extruded filament, and the heated bed.
- Do not wear gloves when operating or repairing to avoid entanglement.
- Keep the printer and all accessories out of reach of children.
- Do not remove or disconnect the USB cable when printing from a computer.
- Do not pull or twist the black cable at any time.
- Do not force or tear anything when unpacking and during setup. This may cause damage to the printer and/or its accessories.
- Do not reach inside the printer during operation.
- Always allow the printer and extruded filament to cool before reaching inside.
- Ensure that the printer is turned off and unplugged from its power source before making repairs or performing service.
- Do not install this device on an unstable surface where it could fall and cause either personal injury or damage to the device and/or other equipment.
- Do not subject the product to extreme force, shock, or fluctuations in temperature or humidity.
- This device is intended for indoor use only.
- Do not expose this device to water or moisture of any kind. Do not place drinks or other containers with moisture on or near the device. If moisture does get in or on the device, immediately unplug it from the power outlet and allow it to fully dry before reapplying power.
- Do not touch the device, the power cord, or any other connected cables with wet hands.
- Use only in a well-ventilated area. Do not use in close, confined spaces.

- Prior to operation, check the unit and power cord for physical damage. Do not use if physical damage has occurred.
- Before plugging the unit into a power outlet, ensure that the outlet provides the same type and level of power required by the device.
- Unplug this device from the power source when not in use.
- Take care to prevent damage to the power cord. Do not allow it to become crimped, pinched, walked on, or become tangled with other cords. Ensure that the power cord does not present a tripping hazard.
- Never unplug the unit by pulling on the power cord. Always grasp the connector head or adapter body.

INTRODUCTION

Thank you for purchasing this MP Mini Delta 3D printer from Monoprice! This printer features a single extruder, which is capable of printing in PLA, ABS, and other materials. You can print from a Windows® or Mac® PC using a USB connection or can print from 3D model files stored on a microSD™ card, without the need for a PC connection of any kind. This printer is easy to setup and easy to use following the instructions in this manual.

FEATURES

- Single extrusion print head
- Can print PLA, ABS, and other materials
- Open frame design for ease of use and maintenance
- USB, microSD™, and Wi-Fi® connectivity options
- Free **WiFi Connect** app available from the Google Play™ store or from iTunes®
- Includes 256MB microSD card with Cura, Repetier-Host, and a sample 3D model (auto00.g)
- One-button printing of any file named **auto00.g** on an installed microSD card

CUSTOMER SERVICE

The Monoprice Customer Service department is dedicated to ensuring that your ordering, purchasing, and delivery experience is second to none. If you have any problem with your order, please give us an opportunity to make it right. You can contact a Monoprice Customer Service representative through the Live Chat link on our website www.monoprice.com during normal business hours (Mon-Fri: 5am-7pm PT, Sat-Sun: 9am-6pm PT) or via email at support@monoprice.com

PACKAGE CONTENTS

Please take an inventory of the package contents to ensure you have all the items listed below. If anything is missing or damaged, please contact Monoprice Customer Service for a replacement.

- 1x MP Mini Delta 3D printer
- 1x Filament holder
- 1x Plastic scraper
- 1x USB cable
- 1x MicroSD™ card
- 3x Hex wrench
- 1x Power adapter
- 1x AC power cord (NEMA 5-15 to IEC 60320 C13)



PRODUCT OVERVIEW

1. Extruder
2. Nozzle
3. Micro USB Port
4. DC Power Connector
5. Quick Access LED Button
6. MicroSD™ Card Slot
7. Filament Holder Slots

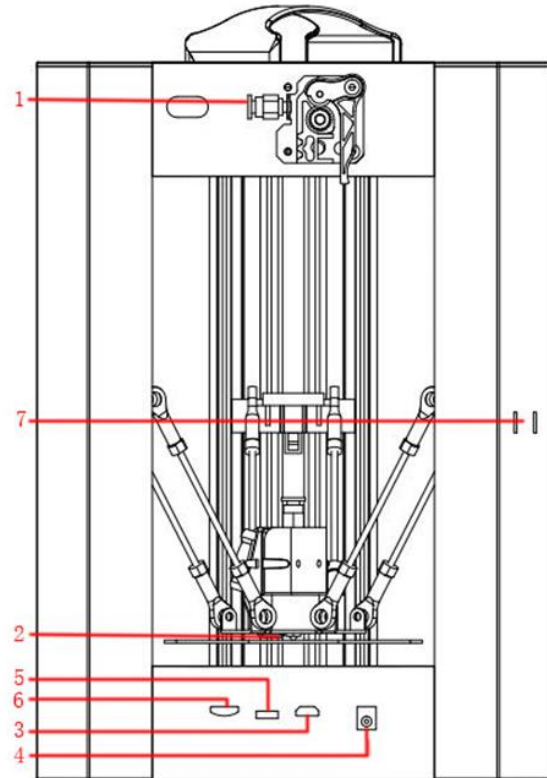

USING THE MENU SYSTEM

- The menu system is displayed on a lighted LCD screen.
- The menu selection highlight or pointer is moved by pressing the top and bottom buttons to the right of the display.
- Press the top button to move the highlight/pointer to the left and up.
- Press the bottom button to move the highlight/pointer to the right and down.
- Press the top button while editing a value to increase that value.
- Press the bottom button while editing a value to decrease that value.
- Press the center button to activate the selected menu item or to save an edited value.

USING THE QUICK ACCESS LED BUTTON

The **Quick Access LED Button (5)** is located between the USB port and microSD™ card slot.

- Ensure that the included microSD card is inserted into the **MicroSD Card Slot (6)** prior to using the **Quick Access LED Button (5)**.
- Press the **Quick Access LED Button (5)** to automatically start printing the **auto00.g** sample model file on the included microSD card (formerly cat.gcode). The LED inside the button will blink green three times, then will remain illuminated green while printing is in progress. Note that any file named **auto00.g** will print automatically when the **Quick Access LED Button (5)** is pressed.
- Press the **Quick Access LED Button (5)** while printing is in progress to pause printing. Printing may continue for 5-10 seconds before it becomes paused. The LED inside the button will extinguish when the print task is paused and will remain extinguished until printing is resumed.
- Press the **Quick Access LED Button (5)** while a print task is paused to resume printing.
- Press and hold the **Quick Access LED Button (5)** for 4 seconds while printing is in progress to cancel the print task. The LED inside the button will extinguish when the print task is cancelled.
- While the printer is idle, press and hold the **Quick Access LED Button (5)** for 4 seconds to initialize the built-in Wi-Fi® Smart Config function for use with the free **MP 3D Printer WiFi Connect** app from the Google Play™ store or from iTunes®. The LED inside the button will blink blue three times, then will extinguish. The Wi-Fi Smart Config function will remain active until the button is pressed again or the printer is powered off.

PRINTER SETUP

Warning! Take care not to remove or damage the black PEI build mat on the build platform. This mat is essential to ensure the 3D model properly adheres to the build platform during printing. If this mat becomes damaged or wears out, replace it with painter's tape, Kapton[®] tape, or ordinary masking tape.

Perform the following steps to prepare the printer for use.

1. Remove the printer from its packaging and place it on a flat, stable surface with plenty of ventilation and a nearby AC power outlet.
2. Open the Accessories box and remove the **Filament Holder**. Slide the tab at the flat end into the **Filament Holder Slots (7)** on the rear of the printer frame.
3. Insert the included microSD™ card into the **MicroSD Card Slot (6)** on the side of the printer.
4. Plug the DC barrel connector on the included AC power adapter into the power connector on the side of the printer. Next, plug the C13 end of the included AC Power Cable into the C14 panel connector on the AC Power Adapter, then plug the other end into a nearby AC power outlet.
5. Press the bottom button once to highlight the **Temperature** entry, then press the center button to select it.
6. Press the center button to select the **Nozzle (2)** temperature value, then use the top and bottom buttons to set the target temperature. Set it to 230°C for ABS filament or set it to 190°C for PLA filament. Press the center button to save the target temperature and begin heating the extruder.

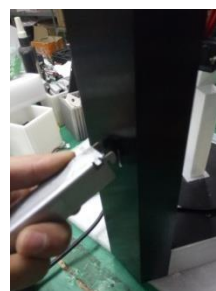

7. While the printer is heating, open your filament. Using a pair of scissors or side cutters, diagonally snip the end of the filament to make a point, as shown in the images below. Place the spool on the **Filament Holder**.

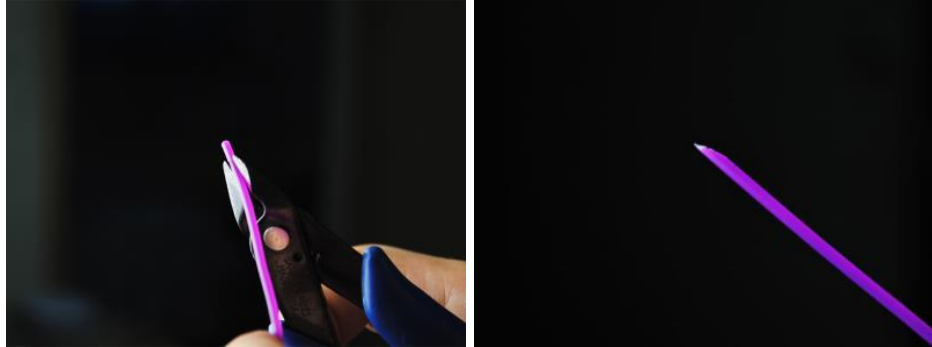

8. Once the target temperature is reached, press the bottom button three times to select the **Exit** option, then press the center button to return to the previous menu page.
9. Press the bottom button to highlight the **Move** option, then press the center button to enter the **Move** menu.
10. The **Extruder** option should be highlighted. Press the center button to select it.
11. While squeezing the lever on the **Extruder (1)**, insert the filament and push it into the opening. Keep pushing until you feel resistance, then release the lever.
12. Press the top button to feed filament into the printer. Allow the motor to run until it stops feeding. Repeat this process until filament starts to extrude out of the **Nozzle (2)**.
13. Using the included plastic scraper, clean the filament from the nozzle and bed.
14. Press the center button to deselect the **Extruder** entry.
15. Press the bottom button twice to highlight the **Exit** entry, then press the center button to return to the previous menu.
16. Press the top button twice to highlight the **Print** option, then press the center button. The printer will read the microSD™ card and display the contents on screen.



17. Use the top and bottom buttons to highlight the **auto00.g** file (formerly cat.gcode), then press the center button to start printing the model.

Congratulations, your 3D printer is setup and you are printing your first model!

COMPLETED PRINT REMOVAL

Perform the following steps to remove a completed print.

1. Wait until the heated bed has cooled to room temperature.
2. Using the included Plastic Scraper, try to wedge it under the print.
3. Continue pushing until the print begins to lift off the bed, try to push the scraper further under the print.
4. If you encounter difficulty pushing the scraper under the print, try approaching it from another side or try working the scraper around the perimeter of the print. Continue pushing until you can slide the scraper all the way under the print, then lift the printed model off the bed surface.

WI-FI SETUP

You can connect the printer wirelessly to a 2.4Ghz Wi-Fi® network to print models from your Android™ or iOS® phone or tablet. Perform the following steps to setup the Wi-Fi connection for your device.

1. Download and install the free **MP 3D Printer WiFi Connect** app from the Google Play™ store or from iTunes®, depending on which type of mobile device you have.
2. Disconnect the USB cable from the printer. You cannot use USB and Wi-Fi connections at the same time.
3. Power on the printer.
4. Start the **MP 3D Printer WiFi Connect** app on your mobile device.

5. The SSID of your Wi-Fi® network should be displayed on the screen of your device. If a different SSID is displayed, open your device's Wi-Fi settings and select the appropriate Wi-Fi network.
6. Enter your WiFi network password.
7. With the printer idle, press and hold the Quick Access LED Button (5) for 4 seconds to initialize the built-in Wi-Fi Smart Config function. Continue holding the button until **Smart config started** is displayed on the screen of your mobile device.
8. Press the **Connect to WiFi** button on your mobile device. The connection will be completed within 10 ~ 60 seconds and the message **MP 3D Printer is now connected to Wi-Fi** will be displayed on your device's screen and the IP address will be displayed at the top of the printer's LCD screen.

Note that you may have difficulty connecting to the Wi-Fi network if you have a 2.4GHz and 5GHz network with the same SSID. Try changing the SSID of the 5GHz network if this occurs. For best results, move the printer to a location closer to the Wi-Fi router or access point.

SOFTWARE INSTALLATION AND SETUP

As you've seen, you can print a model directly from a gcode file on a microSD™ card and this is the preferred method, as it does not require a continuous connection to your computer. You can download gcode files to the microSD card and print them without having to build any model files.

However, you can create your own gcode files using an open source program, such as Cura or Repetier-Host, which are pre-installed on the microSD card that comes with the printer. These programs use M200 models (typically .STL or .OBJ files) and, using machine specific information, generate a gcode file with detailed instructions for the printer to create the selected model. We recommend you start with Cura, since it includes a Slicing Engine.

Installing Cura for Windows®

1. Use a card reader to read the contents on the included microSD™ card. Locate and double-click the **Cura_15.04.2.exe** file to start the setup program.
2. You may choose a new location for the program files or accept the default (recommended). Click **Next** to continue.
3. Ensure that all boxes are checked, then click **Install** to continue.

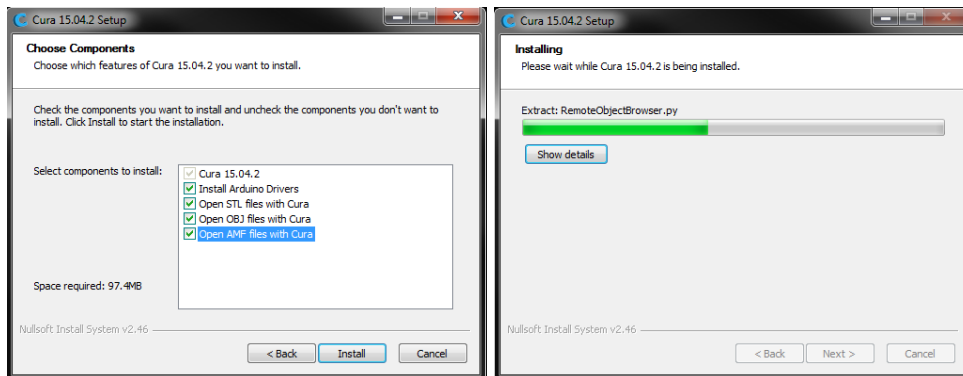
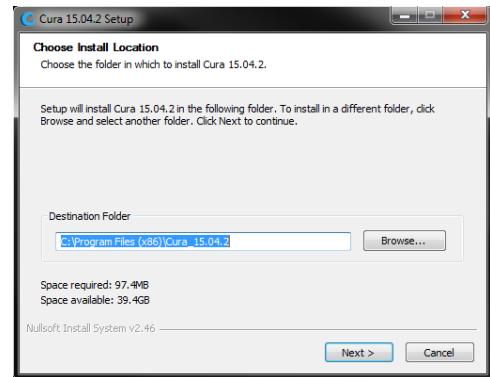

4. Once the files have been extracted and the Cura installation is complete, the driver installation wizard will launch. Click **Next** to continue.

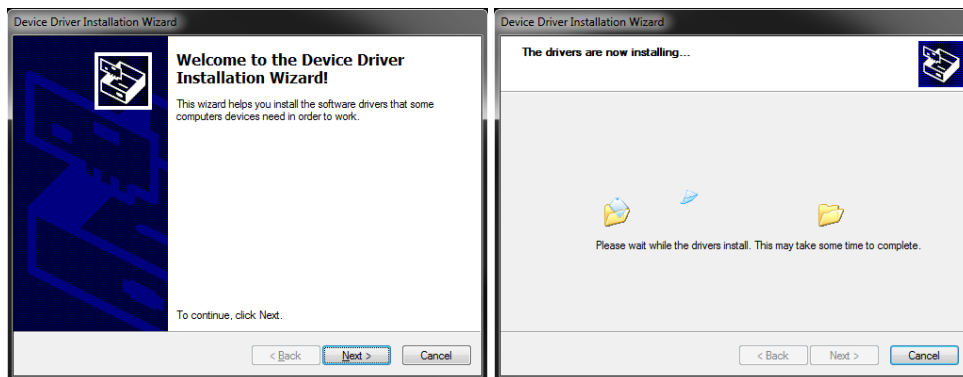

5. Click **Finish** to complete the driver installation.

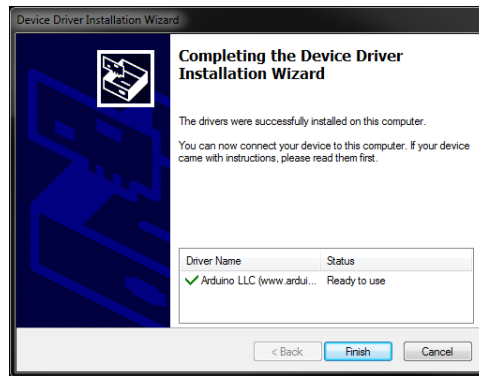

6. Click **Next** to continue.

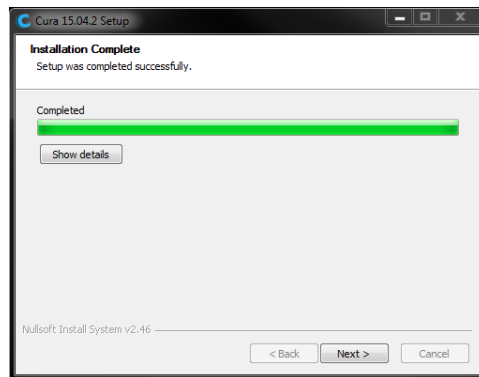

7. Ensure that the box next to the **Start Cura 15.04.2** option is checked, then click **Finish** to complete the installation and launch the program.

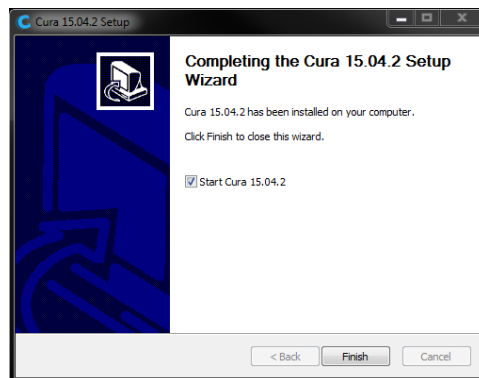

- Wait for Cura to finish launching. If this is the first time you have run Cura on this machine, Cura will automatically launch the **First time run wizard**. Otherwise, you will need to select **Machine > Add new machine**.

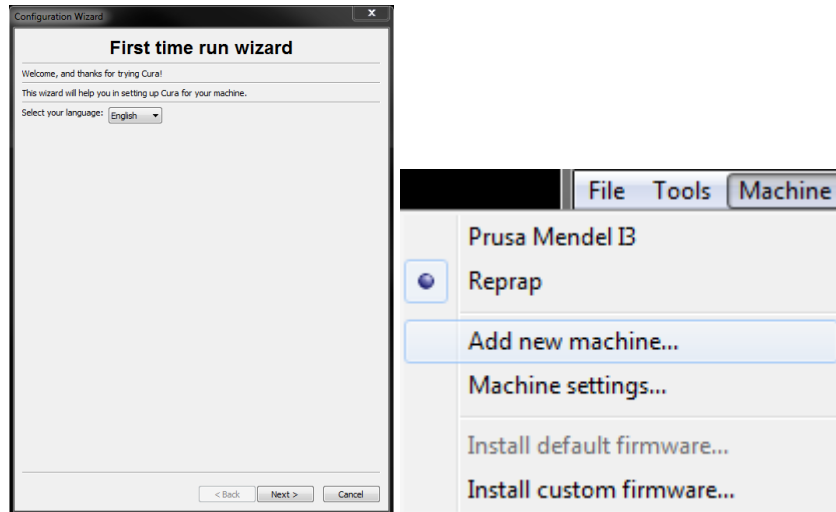

- Click the button next to the **Other** option, then click the **Next** button to continue.

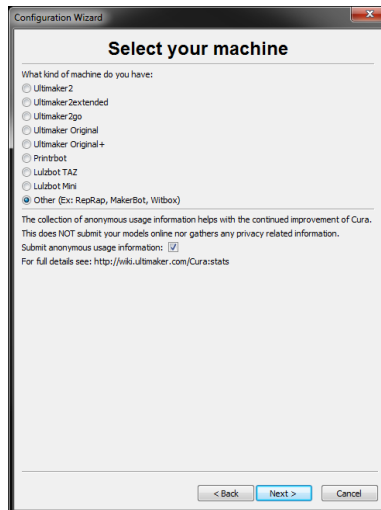

10. Select the **Custom...** option, then click **Next** to continue.

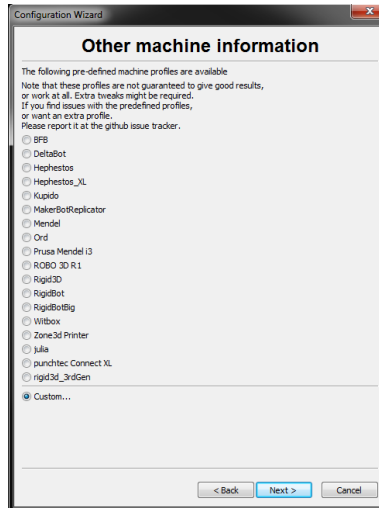

11. Click the button to the left of the **Other** entry, then click **Next** to continue.

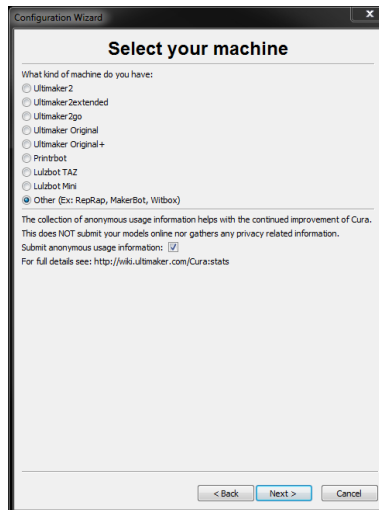

12. Change the settings to match those shown in the images below, then click **Finish** to continue.

The image shows a 'Configuration Wizard' window titled 'Custom RepRap information'. The window contains the following text and fields:

RepRap machines can be vastly different, so here you can set your own settings.
Be sure to review the default profile before running it on your machine.
If you like a default profile for your machine added, then make an issue on github.

You will have to manually install Marlin or Sprinter firmware.

Machine name: Monoprice 21666
Machine width X (mm): 110
Machine depth Y (mm): 110
Machine height Z (mm): 120
Nozzle size (mm): 0.4
Heated bed:
Bed center is 0,0,0 (RoStock):

At the bottom of the window are three buttons: '< Back', 'Finish', and 'Cancel'.

To the right of the window is a summary of the settings:

Machine name: Monoprice 21666
Machine width X (mm): 110
Machine depth Y (mm): 110
Machine height Z (mm): 120
Nozzle size (mm): 0.4
Heated bed:
Bed center is 0,0,0 (RoStock):

13. The program will finish launching and leave you on the main screen. Select the **Basic** tab, then change the settings to match those in the accompanying image for PLA filament.

Note that the **Fill density**, **Support type**, and **Platform adhesion type** options should be set according to the needs of the model you are printing.

The **Fill density** will determine the overall strength of the finished object. If printing a decorative object, a low fill density is appropriate. However, if printing an object that will be used as a tool or part (e.g., a gear), a high fill density will impart maximum structural strength to the finished object.

If printing something with no overhang, such as a cube, you can set the **Support type** to **None**. If the model has areas that overhang the build plate, but which are not overhanging a lower section, you can use the **Touching buildplate** option. The **Everywhere** option is usually only necessary for very complex models with parts that overhang other parts.

In most cases, the **Brim** option for the **Platform adhesion type** is sufficient and is easier to remove and clean up. The **Raft** option builds a flat layer on which the model is then built and will need to be removed once the print is complete.

Feel free to experiment with these options to achieve the best possible print.

14. Click the **Advanced** tab, then change the settings to match those in the accompanying image. Note that if you have a very high fill density (from the

Basic	Advanced	Plugins	Start/End-GCode
Quality			
Layer height (mm)	0.1		
Shell thickness (mm)	0.8		
Enable retraction	<input checked="" type="checkbox"/>		...
Fill			
Bottom/Top thickness (mm)	0.6		
Fill Density (%)	20		...
Speed and Temperature			
Print speed (mm/s)	50		
Printing temperature (C)	210		
Bed temperature (C)	0		
Support			
Support type	Touching buildplate		...
Platform adhesion type	Brim		...
Filament			
Diameter (mm)	1.75		
Flow (%)	100.0		

previous step), you will want to increase the **Cool** down time (**Minimal layer time**) to 10 seconds.

15. Click the **Start/End-GCode** tab.

16. Add the following line to the **start.gcode** code, after the 2nd **G28** line (the new line is highlighted in the image below):

G29 C-0.8 Z0.3 auto-levels the build plate with a vertical offset of 0.3mm and a center offset of -0.8mm

The models on the included microSD™ card have this line already inserted, but if you will be making your own model files, you will need this line to instruct the printer to activate the auto-leveling feature. The 0.3 value represents the amount of vertical offset intended to compensate for the thickness of the build plate mat. If the first layer is too tight, you can increase this value, while if the first layer is too loose, you can decrease it. This value has a 0.1mm tolerance.

Basic	Advanced	Plugins	Start/End-GCode
Machine			
Nozzle size (mm)		0.4	
Retraction			
Speed (mm/s)		40.0	
Distance (mm)		4.5	
Quality			
Initial layer thickness (mm)		0.3	
Initial layer line width (%)		100	
Cut off object bottom (mm)		0.0	
Dual extrusion overlap (mm)		0.15	
Speed			
Travel speed (mm/s)		150.0	
Bottom layer speed (mm/s)		20	
Infill speed (mm/s)		0.0	
Top/bottom speed (mm/s)		0.0	
Outer shell speed (mm/s)		0.0	
Inner shell speed (mm/s)		0.0	
Cool			
Minimal layer time (sec)		5	
Enable cooling fan		<input checked="" type="checkbox"/>	

```
start.gcode
end.gcode

;Sliced at: {day} {date} {time}
;Basic settings: Layer height: {layer_height} Walls: {wall_thickness} Fill: {fill_density}
;Print time: {print_time}
;Filament used: {filament_amount}m {filament_weight}g
;Filament cost: {filament_cost}
;M190 S{print_bed_temperature} ;Uncomment to add your own bed temperature line
;M109 S{print_temperature} ;Uncomment to add your own temperature line
G21 ;metric values
G90 ;absolute positioning
M82 ;set extruder to absolute mode
M107 ;start with the fan off
G28
G29 C-0.8 Z0.3 ;auto-levels the build plate with a vertical offset of 0.4mm
G1 Z15.0 F{travel_speed} ;move the platform down 15mm
G92 E0 ;zero the extruded length
G1 F200 E3 ;extrude 3mm of feed stock
G92 E0 ;zero the extruded length again
G1 F{travel_speed}
;Put printing message on LCD screen
M117 Printing...
```

17. Finally, using the included Micro USB cable, plug one end into the USB port on the printer, then plug the other end into an available USB port on your computer. Watch the right hand corner of the screen. A bubble will appear in the lower right corner of your desktop, which is telling you that Windows® is installing the necessary printer drivers. Click the bubble and verify that the drivers have been properly installed.

Congratulations, you have installed Cura and connected your PC to your new 3D printer. Refer to Cura's documentation for operating details and information on the various options.

Repetier-Host

You can also install Repetier-Host from the file on the included microSD™ card or from a download from the internet. The screenshots below show the proper settings to use for this printer in Repetier-Host.

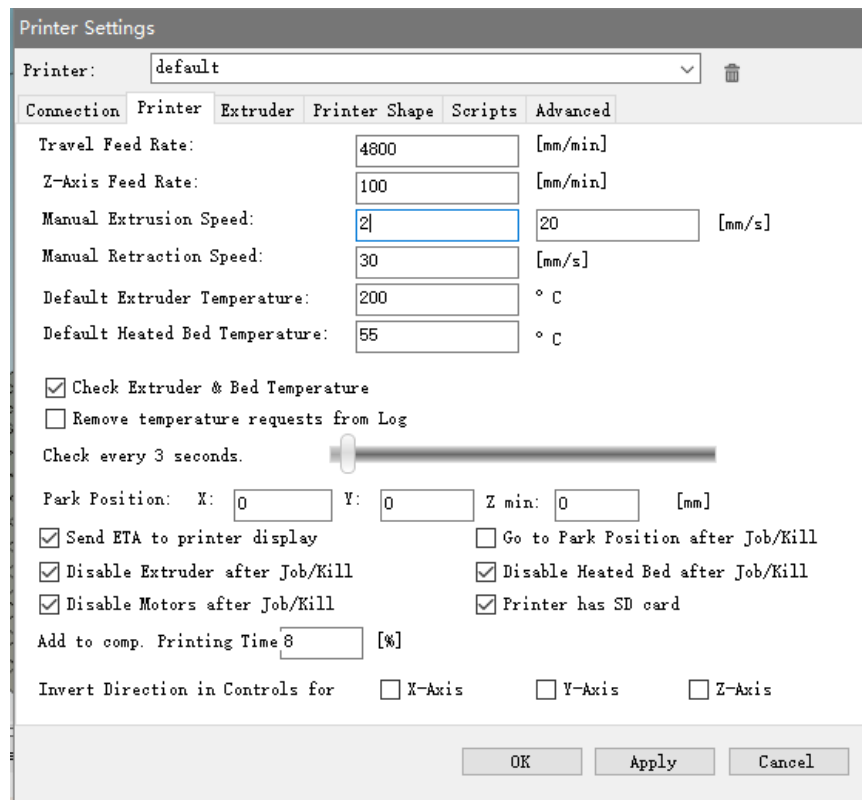

Printer Settings

Printer: default

Connection Printer **Extruder** Printer Shape Scripts Advanced

Number of Extruder: 1

Max. Extruder Temperature: 250

Max. Bed Temperature: 60

Max. Volume per second: 12 [mm³/s]

Printer has a Mixing Extruder (one nozzle for all colors)

Extruder 1

Name:

Diameter: 0.4 [mm] Temperature Offset: 0 [° C]

Color: ██████████

Offset X: 0 Offset Y: 0 [mm]

OK Apply Cancel

Printer Settings

Printer: default

Connection Printer Extruder **Printer Shape** Scripts Advanced

Printer Type: Classic Printer

Home X: Min Home Y: Min Home Z: Min

X Min: 0 X Max: 110 Bed Left: 0

Y Min: 0 Y Max: 110 Bed Front: 0

Print Area Width: 110 mm

Print Area Depth: 110 mm

Print Area Height: 110 mm

The min and max values define the possible range of extruder coordinates. These coordinates can be negative and outside the print bed. Bed left/front define the coordinates where the printbed itself starts. By changing the min/max values you can even move the origin in the center of the print bed, if supported by firmware.

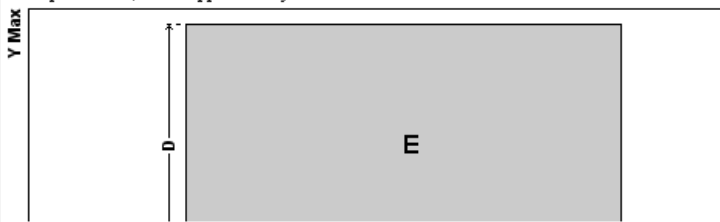

OK Apply Cancel

TECHNICAL SUPPORT

Monoprice is pleased to provide free, live, online technical support to assist you with any questions you may have about installation, setup, troubleshooting, or product recommendations. If you ever need assistance with your new product, please come online to talk to one of our friendly and knowledgeable Tech Support Associates. Technical support is available through the online chat button on our website www.monoprice.com during regular business hours, 7 days a week. You can also get assistance through email by sending a message to tech@monoprice.com

REGULATORY COMPLIANCE

Notice for FCC



This device complies with part 15 of the FCC Rules. Operation is subject to the following two conditions: (1) This device may not cause harmful interference, and (2) this device must accept any interference received, including interference that may cause undesired operation.

Changes or modifications not expressly approved by the party responsible for compliance could void the user's authority to operate the equipment.

Notice for Industry Canada

This Class B digital apparatus complies with Canadian ICES-003.

Cet appareil numérique de la classe B est conforme à la norme NMB-003 du Canada.

Microsoft® and Windows® are registered trademarks of Microsoft Corporation in the United States and/or other countries.

Apple®, Mac®, and OS X® are trademarks of Apple Inc., registered in the U.S. and other countries.

SD™ and microSD™ are trademarks of SD-3C, LLC in the United States, other countries, or both.

DuPont™ and Kapton® are trademarks or registered trademarks of E.I. du Pont de Nemours and Company.

Wi-Fi® is a registered trademark of Wi-Fi Alliance.